

This test point is a connection to one of the mounting holes

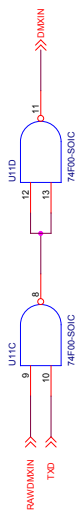

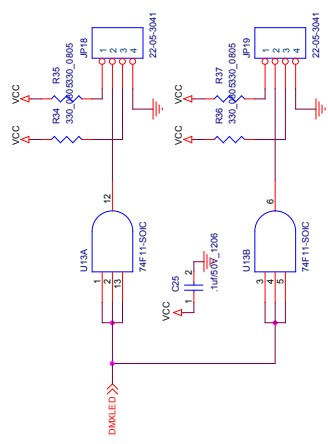
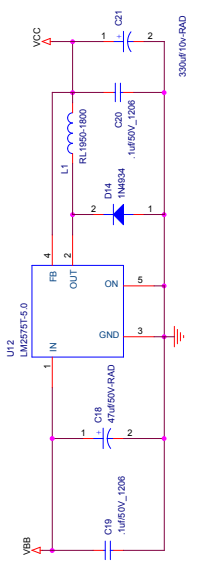
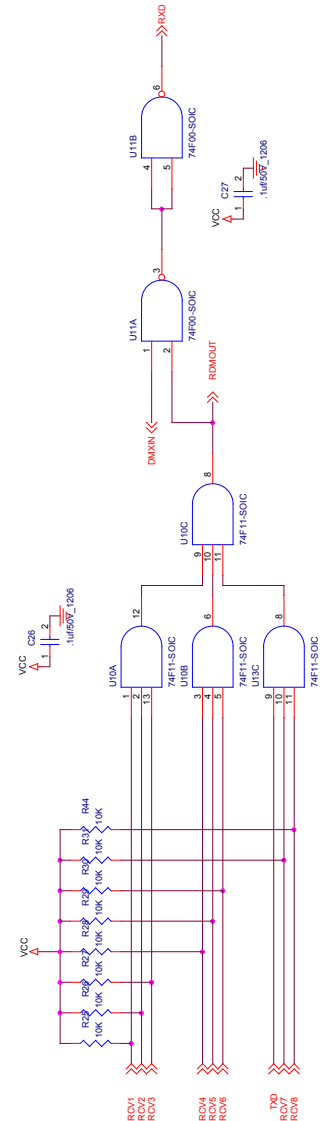
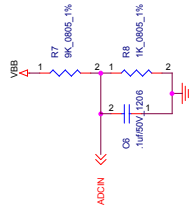
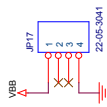
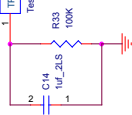
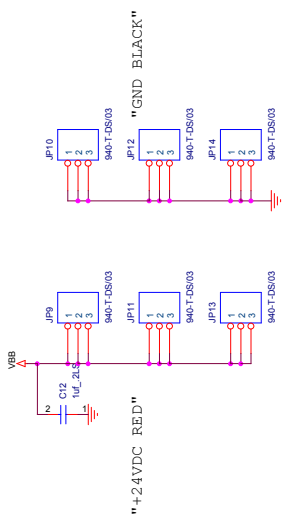
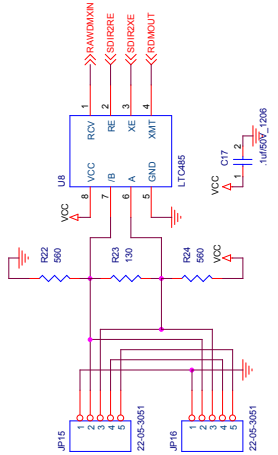
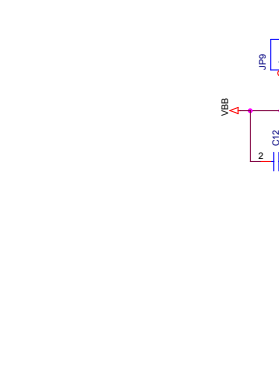
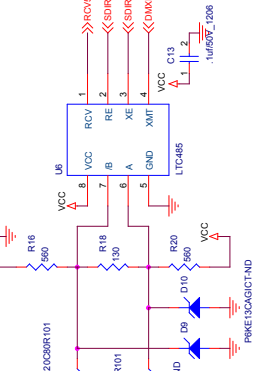
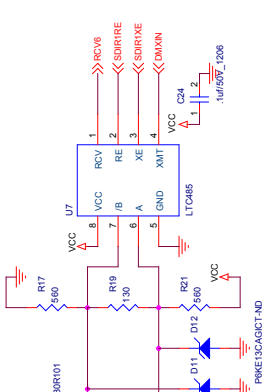
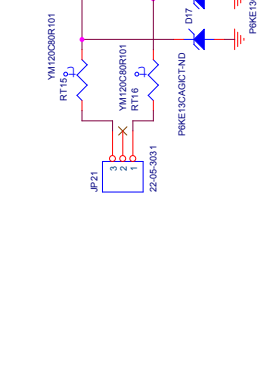
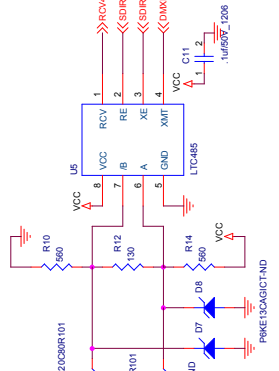
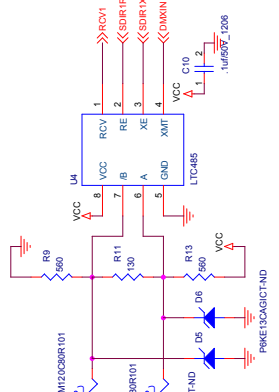
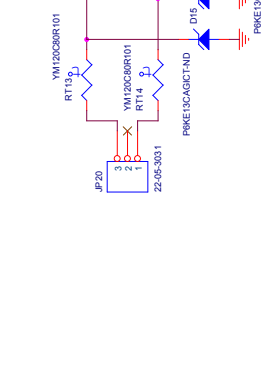
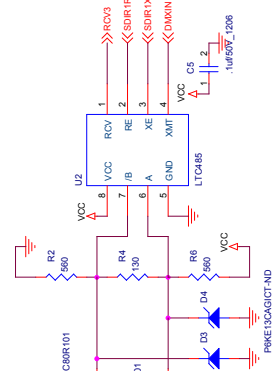
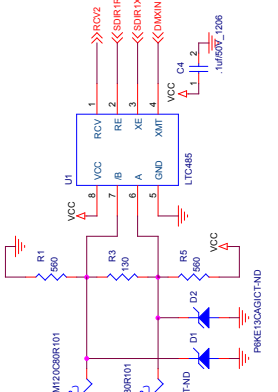

31a. E2470C Between these headers these wire up 110v on the power supply sample

31a. Between these headers these wire up 110v on the power supply sample

" DMX IN "

" DMX OUT "